



**WEIDA**®

PRECISION CASTING

**威海威达精密铸造有限公司**  
Weihai Weida Precision Casting Co., Ltd.



## ABOUT US 企业简介

威海威达精密铸造有限公司隶属山东威达机械股份有限公司（上市公司 深交所：002026），地处胶东半岛交通便利的美丽海滨城市威海，公司成立于2005年，企业占地面积20多万平方米，建筑面积3.2万平方米，2007年公司通过ISO/TS16949质量管理体系认证，2009年通过ISO9001:2000质量体系认证。年销售收入1.2亿元，出口创汇900多万美元。

公司采用国际先进的硅溶胶工艺及复合工艺，专业从事熔模精密铸造产品的制造加工，主要生产普通碳素钢，低合金钢，不锈钢，耐热钢，耐磨铸钢，片状石墨高镍奥氏体铸铁ISO2892.1973(E)，牌号：L-NiCuCr1562、高镍奥氏体耐腐蚀球墨铸铁、蒙乃尔等80多种材质的精密铸件，产品应用十分广泛，主要用于：航空、船舶、汽车、电动工具、气动工具、五金工具、工程机械、石油、建筑、水泵、阀体、水利、电力、消防器材、体育用品等行业。现主要配套厂商：香港TTI公司、博世公司、南京德朔公司、日本SMC公司、中国重汽、山东华源莱动内燃机有限公司、浙江中马集团、胜利油田机械集团、青岛外贸等大型公司。

公司现有员工450多人，从事专业精密铸造的高级工程师10人，各类工程技术人员40多名，拥有一系列国内领先的铸造设备、机械加工中心、检测仪器设备等共计518多套，公司具有高水平的研发、制造、检测、试验能力及科学规范的管理体制。

公司经营理念：以质量求生存 全员参与 强化管理  
以创新谋发展 精益求精 铸造品质

公司服务宗旨：将竭诚为客户提供最优质的产品 & 最真诚的服务  
威海威达精密铸造有限公司热忱欢迎各界朋友光临指导，真诚合作。





“

Weihai Weida Precision Casting Co., Ltd belongs to Shandong Weida Machinery Co., Ltd (a listed company in Shenzhen Stock Exchange, stock code: 002026), which is located in the beautiful coast city - Weihai in Jiaodong Peninsula. Founded in 2005, the company occupies a land area of over 200000 square meters including building area of 32000 square meters. The company passed the quality management certification ISO/TS16949 in 2007 and ISO9001:2000 in 2009. The company annual sales revenue is 120 million RMB including export revenue more than 9 million USD.

The company adopts international advanced silica sol technique and combined technique, specializes in the production of lost wax precision casting parts, mainly produces precision casting parts with carbon steel, low-alloy steel, stainless steel, heat resistant steel, wear resistant steel, flake graphite hi nickel austenitic cast iron (ISO2892.1973E: L-NiCuCr1562), hi nickel austenitic corrosion resisting nodular cast iron, monel and others total 80 kinds of materials. The company's products are widely used in the industry of aviation, shipping, automobile, power tools, pneumatic tools, hardware tools, engineering machinery, petroleum, construction, pump, valves, water conservancy, electric power, fire extinguisher, sports equipments etc.

The company's major customers are Hongkong TTI, Bosch, Nanjing Chervon, Japan SMC, China Sino-truck, Shandong Huayuan laidong IC Engine Co Ltd, Zhejinag Zhongma Group, Shengli Oilfield Machinery Group, Qingdao Foreign Trade etc.

The company has more than 450 staffs, 10 senior engineers specializing in professional precision casting R&D, more than 40 engineers and technicians. The company owns over 518 sets various domestic leading advanced casting equipments, CNC machining equipments and testing equipments. The company owns advanced R&D, manufacturing, inspection and testing ability and scientific standard management system.

The company's management principle:

Survival with quality, participation of entire staff, strengthening management  
Development through Innovation, striving for perfection, casting quality brand

The company's service aim:

Provide the best quality products and the most sincere service for customers

Weihai Weida Precision Casting Co., Ltd. warmly welcomes friends from all walks of life to visit our company for guidance and sincere cooperation.

”



# 硅溶胶熔模铸造技术参数

## silica sol lost wax technology parameter

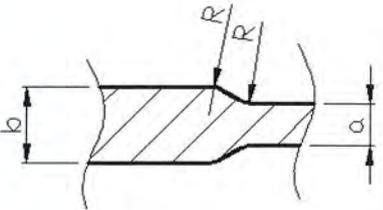
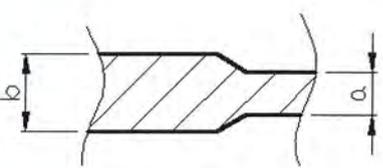
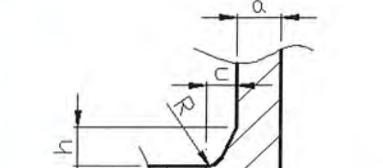
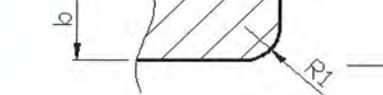
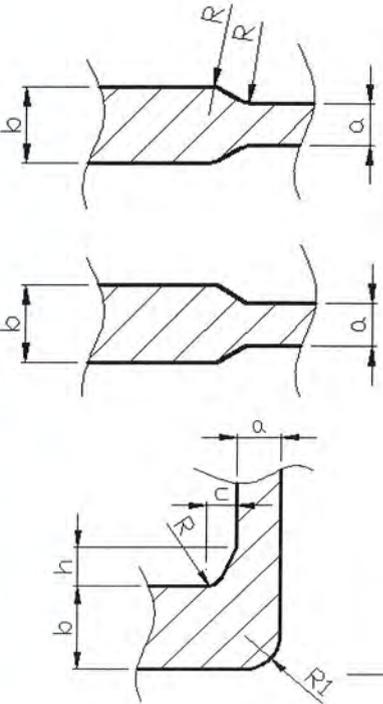
	铸件尺寸范围mm	一般公差mm	特别公差mm	(ISO)CT	铸件规格
尺寸 dimension	±5	±0.12	±0.08	2级	最优：80~160mm
	10~25	±0.25	±0.25	3级	最大：500~550mm
	25~50	±0.4	±0.4	4级	铸造重量（黑色金属）：0.25
	50~75	±0.5	±0.5	5级	~1.5KG,最大：20KG
	75~100	±0.7	±0.7	5级	铸造表面度：平均12S
	100~150	±0.85	±0.85	5~6级	表面粗糙度：3.2~1.6
	150~200	±0.9	±0.9	6级	铸造最小厚度：0.8~1.5mm
	200以上	±1.0%	±1.0%	7级	铸造重量公差MT:5~7级
真圆度公差 roundness tolerance	10mm	±0.1	±0.08	机械 加工 余量	100mm以下 0.5~0.6
	15~25mm	±0.2	±0.15		100~160mm 0.8~0.9
	32~45mm	±0.3	±0.2		160~200mm 1~1.5
	50~75mm	±0.4	±0.3		
	75~100mm	±0.7	±0.4		
角度公差 angle tolerance	45°以下	±0.5°	±0.5°		
	45°~90°	±1°	±1°		
	一般	±2°			
铸造圆角设计为 casting fillet should be designed as		$b \leq 2a$	铸钢	$R \geq (1/6 \sim 1/3)(a+b)/2$	
		$b > 2a$	铸钢	$R \approx (a+b)/4$	
		$b > 2a$	铸钢	$L > 4(b-a)$	
		$b > 2a$	铸钢	$L > 5(b-a)$	
	$b > 2a$		$R \geq (1/6 \sim 1/3)(a+b)/2$ ; $R1 \geq R + (a+b)/2$ ; $C \approx 3(a+b)$ ; $h \geq (4 \sim 5)/C$		

# 产品加工

## Products machining



威达济南一机CNC机床

Weida JFMT CNC Machine



线切割机、电火花机

wire-electrode discharge machine,  
electric discharge machine



全景CNC

Panoramic CNC



先进数控机床

Advanced CNC machine

# 产品质检

## Products quality inspection



三坐标检测仪

Three coordinate measuring instrument



投影仪/硬度仪

Projector / Hardness tester



拉伸试验机

Cupping machine



磁粉探伤仪

Magnetic particle detector



东方直读光谱仪

Direct-reading spectrometer



冲击试验机

Impact testing machine

# 产品铸造

Products casting



脱蜡釜蜡自动处理机

Automatic processor for lost wax and still wax



型壳焙烧炉

Molding shell roasting furnace



免缸双工位射蜡机

Cylinder-free double station wax injection machine



自动/半自动射蜡机

Automatic/semi-automatic wax injection machine



型壳干燥悬挂链

Suspension chain for drying of molding shell



全景双工位射蜡机

Panoramic double station wax injection machine



# 产品介绍

## Products introduction



01

### 电动工具配件

Parts for power tools



名称: 中板, 面板, 滑块, 盖板  
材质: 42CrMo, S45C  
Name: medium plate, panel, slider, cover plate  
material: 42CrMo, S45C

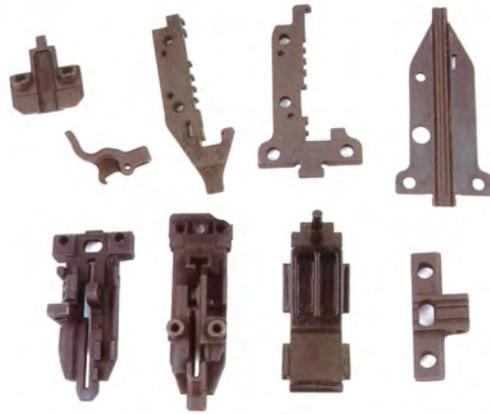

02

### 电动工具配件

Parts for power tools



名称: 中板, 面板, 尾盖  
材质: 42CrMo, S45C  
Name: medium plate, panel, rear cover  
material: 42CrMo, S45C

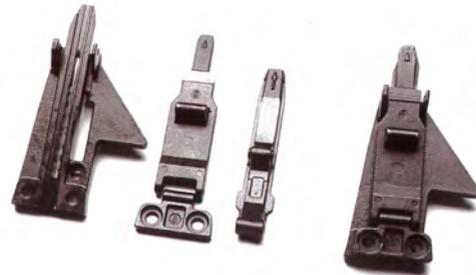

03

### 电动工具配件

Parts for power tools



名称: 中板, 面板, T形块  
材质: 42CrMo, S45C  
Name: medium plate, panel, T shape block  
material: 42CrMo, S45C

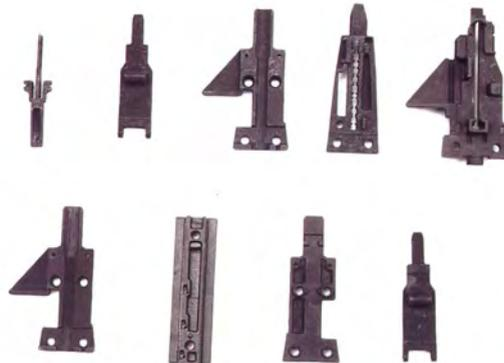

04

### 电动工具配件

Parts for power tools



名称: 传动器  
材质: 42CrMo  
Name: driver  
material: 42CrMo



# 产品介绍

## Products introduction



### 电动工具配件

Parts for power tools



名称: 打孔器

材质: AISI4140

Name: hole saw

material: AISI4140

05



### 电动工具配件

Parts for power tools



名称: 齿轮壳

材质: 4140

Name: Gear housing

material: 4140

06



### 电动工具配件

Parts for power tools



名称: 不锈钢套

材质: 304

Name: Stainless steel bush

material: 304

07



### 电力工具配件

Parts for electric power tools



名称: 电缆钳

材质: Cr5Mo1V

Name: Cable plier  
material: Cr5Mo1V



08

### 汽车配件

Automobile parts



名称: 枪嘴

材质: SCM440

Name: Gun nozzle  
material: SCM440



09

### 汽车配件

Automobile parts



名称: 法兰

材质: 40Cr

Name: flange  
material: 40Cr



10

### 气动工具配件

Parts for pneumatic tools



名称: 连接块, 连接座

材质: SKD11, SCM435

Name: Link block, link base  
material: SKD11, SCM435



11

### 不锈钢配件

Stainless steel parts

名称: 壳体, 叶片

材质: SCS13

Name: case, blade

material: SCS13



12

### 电动工具配件

Parts for power tools



名称: 手柄, 垫片, 快夹主体

材质: SCM415, S45C

Name: handle, cushion, quick clamping body

material: SCM415, S45C



13

### 电动工具配件

Parts for power tools



名称: 快换接头

材质: Z8nAl4-1

Name: quick change connector

material: Z8nAl4-1



14



### 电动工具配件

Parts for power tools



名称: 冲击块, 主轴

材质: 8620, 20CrNiMo

Name: impact piece, principal shaft  
material: 8620, 20CrNiMo

15



### 电动工具配件

Parts for power tools



名称: 主轴, 输出轴

材质: 8620, 20CrNiMo

Name: principal shaft, output shaft  
material: 8620, 20CrNiMo

16



### 电动工具配件

Parts for power tools



名称: 拨片, 安全阀, 支撑柱,  
连接臂, 钉枪配件保险扣

材质: 42CrMo, 20CrMo, SCM440

Name: Pick, safety valve, shore, connecting  
arm, safety buckle for nail gun  
material: 42CrMo, 20CrMo, SCM440

17



### 电动工具配件

Parts for power tools



名称: 变速衬套, 冲击块

材质: H13, 20CrNiMo

Name: shifting bush, impact piece  
material: H13, 20CrNiMo

18



# 产品介绍

## Products introduction



### 电动工具配件

Parts for power tools



19

名称: 棘轮, 连接臂, 锁扣  
材质: 4145, SCM415, 20CrNiMo  
Name: ratchet, connecting arm, lock catch  
material: 4145, SCM415, 20CrNiMo



### 电动工具配件

Parts for power tools



20

名称: 支架, 滑块, 固定块  
材质: AISI4145, S45C  
Name: support, slider, fixed block  
material: AISI4145, S45C



### 阀体 电动工具配件

valves, Parts for power tools



21

名称: 球笼, 蜗杆轴承固定盖, 端盖  
材质: 20CrNiMo, SCM415  
Name: ball cage, fixing cover, end cap  
material: 20CrNiMo, SCM415



# 产品介绍

## Products introduction

### 重型卡车配件

Parts for heavy truck



名称: 摇臂座, 支撑块, 滑块

材质: SCM415, S45C

Name: rocker-arm base, support, slider

material: SCM415, S45C



22

### 电动工具配件

Parts for power tools



名称: 往复杆支架, 拨叉

材质: 16MnCr5, SCM415

Name: reciprocating rod support, fork

material: 16MnCr5, SCM415



23

### 五金工具配件

Parts for hardware

名称: 连接臂, 齿轮轴

材质: 20CrMo, 8620

Name: connecting arm, gear shaft

material: 20CrMo, 8620



24

### 五金工具配件

Parts for hardware

名称: 摆动杆, 小钉锤

材质: S45C, GCr15

Name: swing rod, small hammer

material: S45C, GCr15



25



**WEIDA**®

地址：山东省文登市二龙山工业园文明路1号

Add:1 Wenming Rd , ErLongshan industrial zone Wendeng

City , Shandong Province of China

电话(Tel):0086-631-3909887 3909886 3909188

传真(Fax):0086-631-3909992

E-mail: yzq@weidapeacock.com

sales@weidapeacock.com

Http://www.weidapeacock.com